



IJF Grand Prix Tunis 2010

(TUN Tunis, 07-09 May 2010)

-60 kg

28 Judoka

Pool A

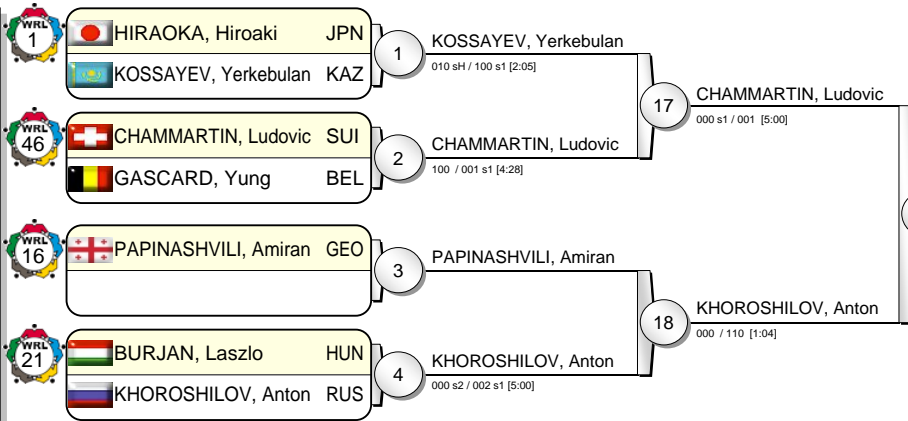

Pool B

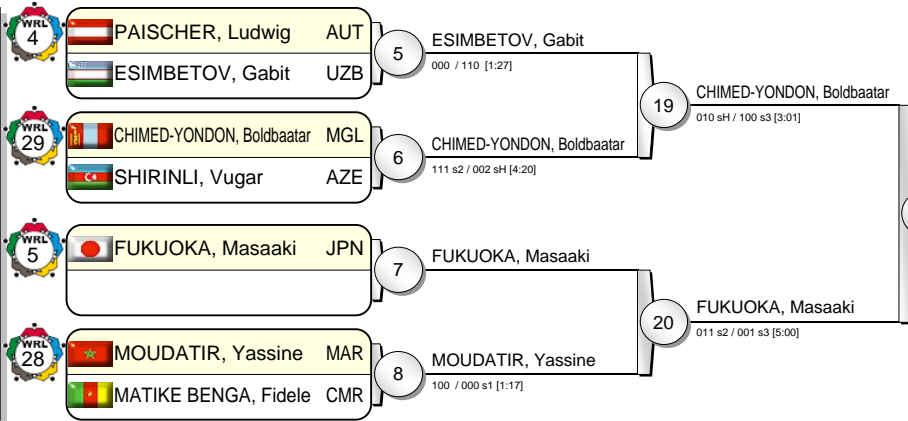

Pool C

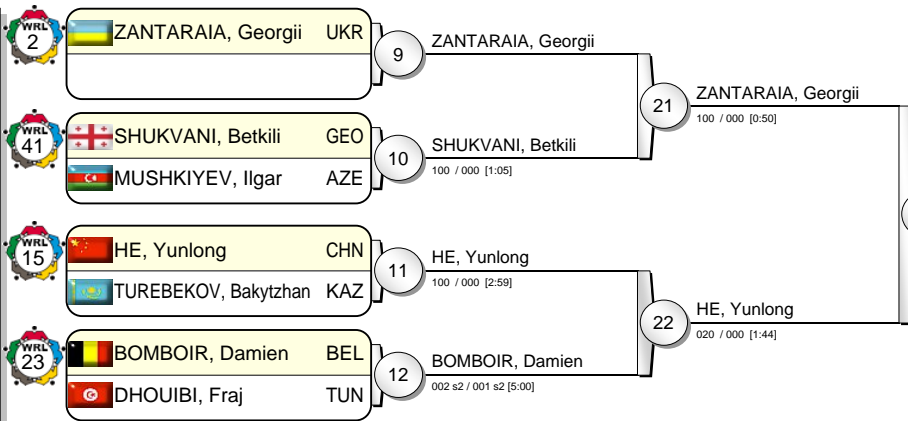

Pool D

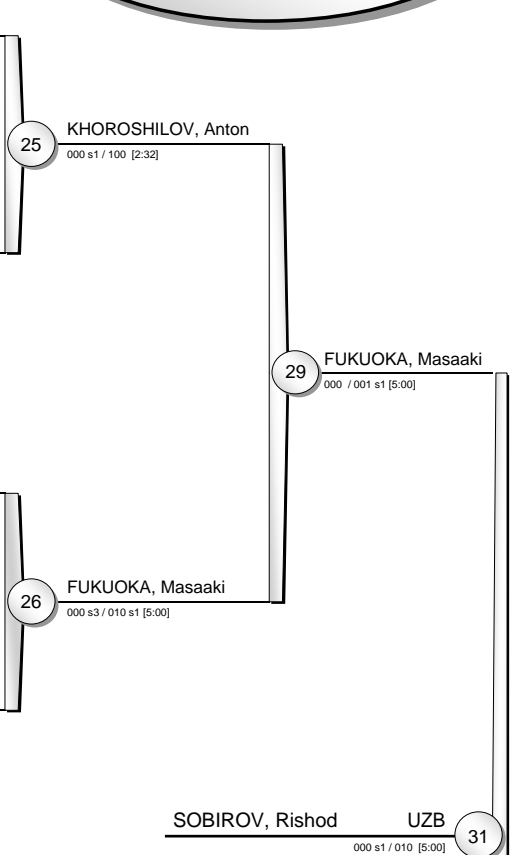
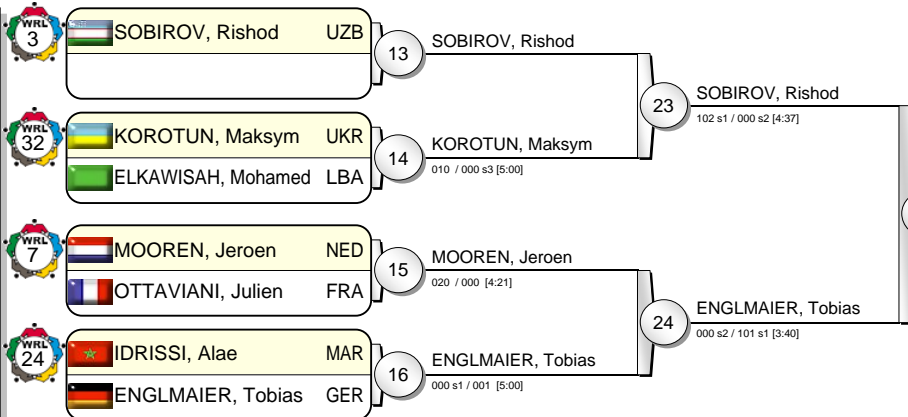

SOBIROV, Rishod UZB 000 s1 / 010 [5:00] 31

Results

- | | | |
|------------------------------|-----|--|
| 1. SOBIROV, Rishod | UZB | |
| 2. FUKUOKA, Masaaki | JPN | |
| 3. KHOROSHILOV, Anton | RUS | |
| 3. ZANTARAIA, Georgii | UKR | |
| 5. CHAMMARTIN, Ludovic | SUI | |
| 5. CHIMED-YONDON, Boldbaatar | MGL | |
| 5. HE, Yunlong | CHN | |
| 5. ENGLMAIER, Tobias | GER | |





IJF Grand Prix Tunis 2010

(TUN Tunis, 07-09 May 2010)

-66 kg

35 Judoka

Pool A

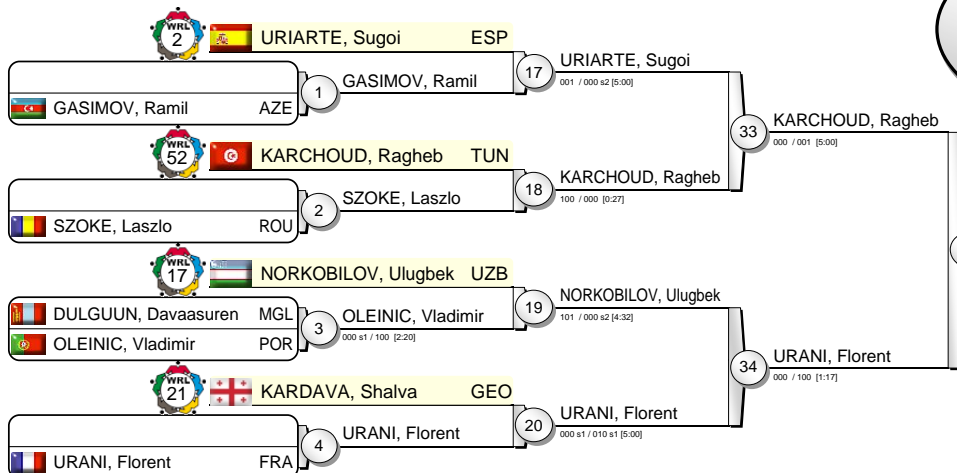

Pool B

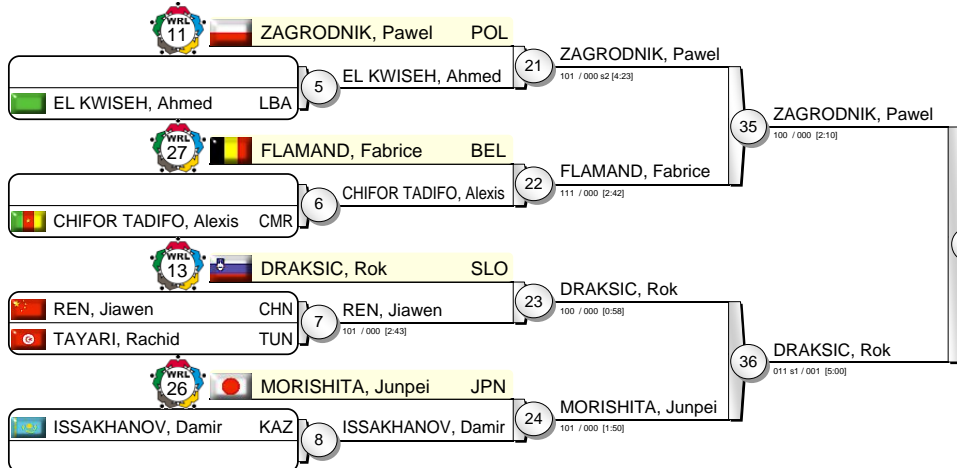

Pool C

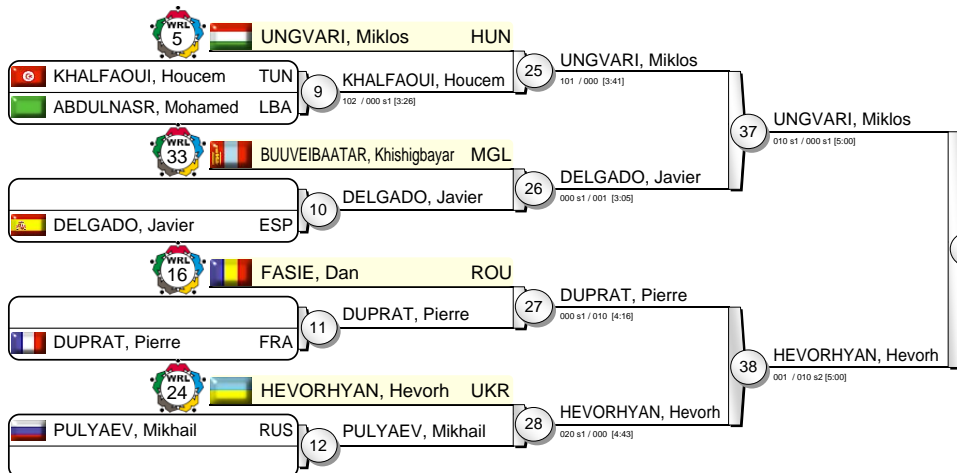

Pool D

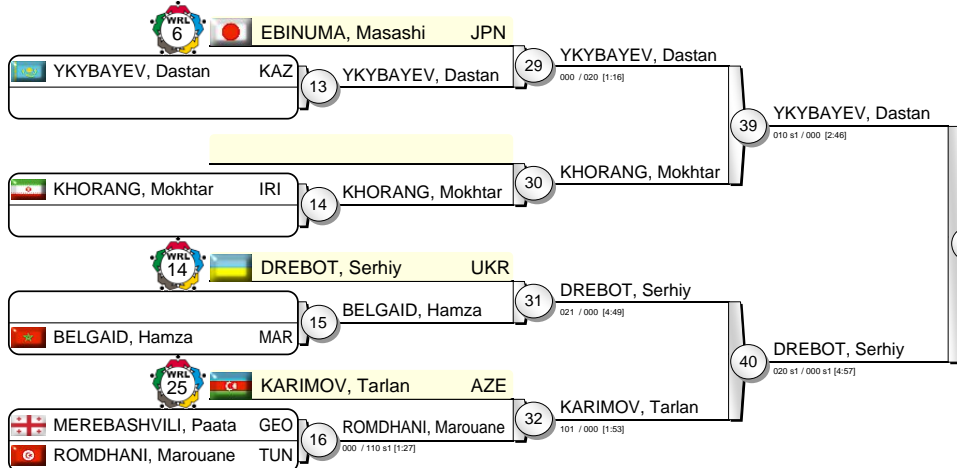

DRAKSIC, Rok

100 / 011 s1 [4:50]

47

Results

1. DRAKSIC, Rok SLO
2. UNGVARI, Miklos HUN
3. URANI, Florent FRA
3. YKYBAYEV, Dastan KAZ
5. KARCHOUD, Ragheb TUN
5. ZAGRODNIK, Pawel POL
5. HEVORHYAN, Hevorh UKR
5. DREBOT, Serhiy UKR





IJF Grand Prix Tunis 2010

(TUN Tunis, 07-09 May 2010)

-73 kg

42 Judoka

Pool A

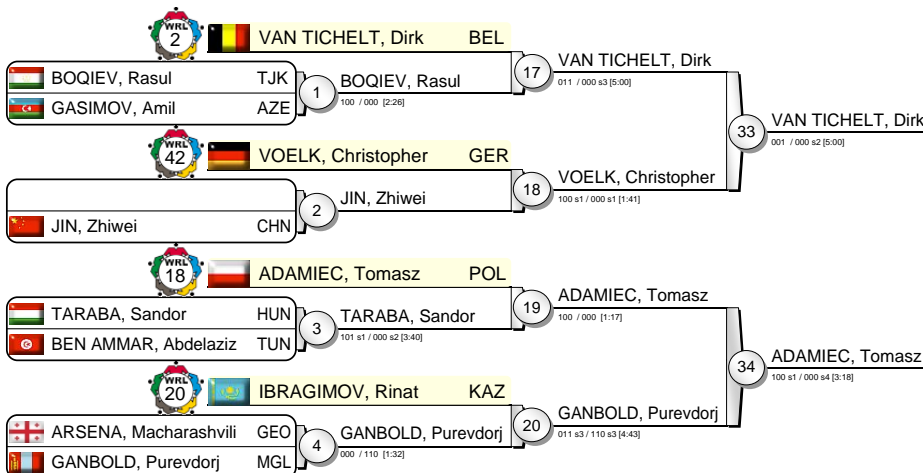

Pool B

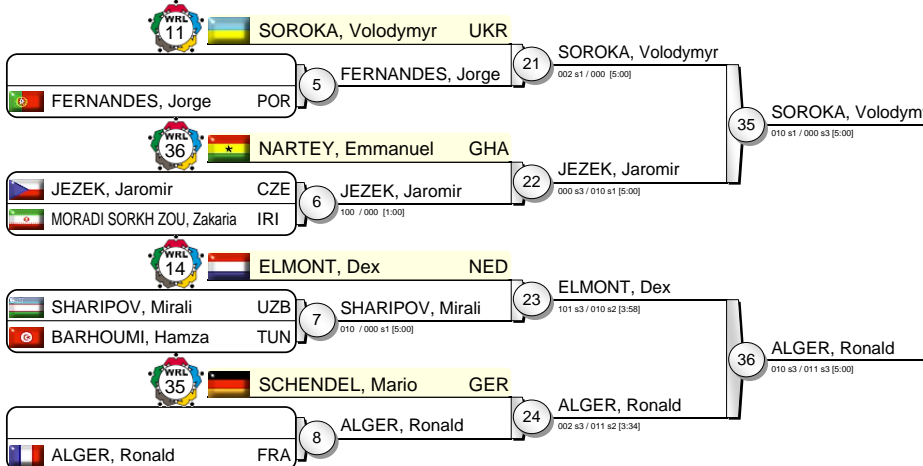

Pool C

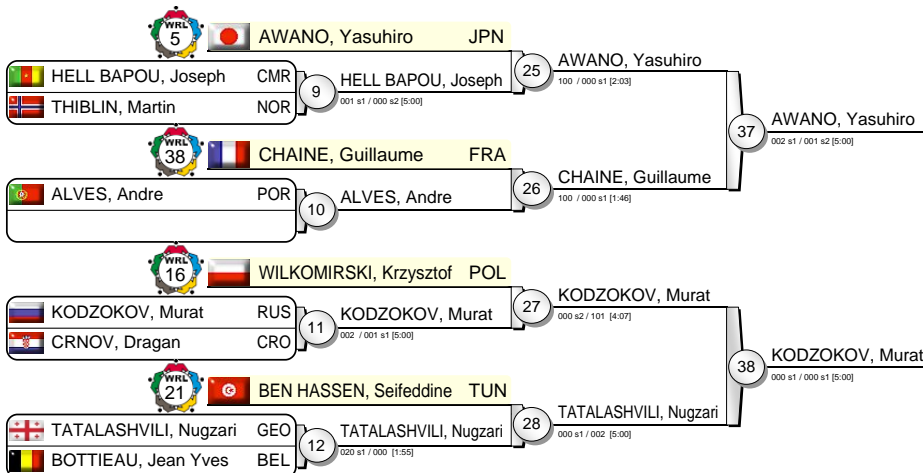

Pool D

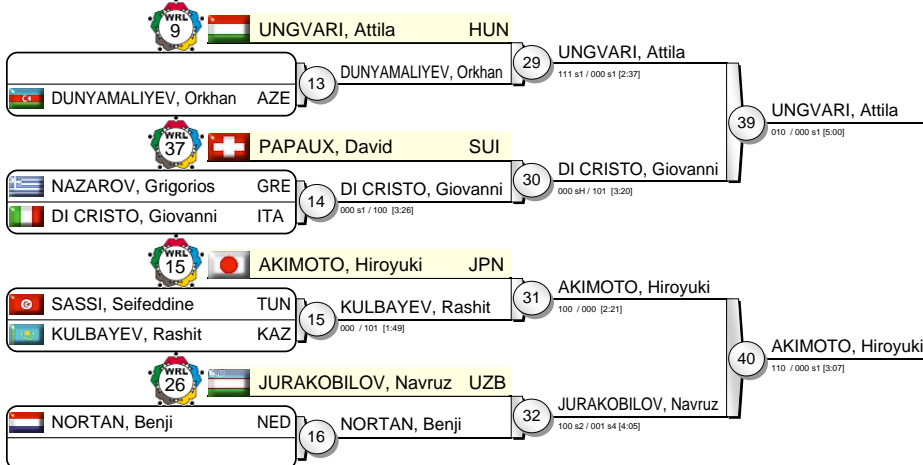

SOROKA, Volodymyr

100 / 001 [1:52]

47

Results

- SOROKA, Volodymyr
- AKIMOTO, Hiroyuki
- VAN TICHELDT, Dirk
- KODZOKOV, Murat
- ADAMIEC, Tomasz
- ALGER, Ronald
- AWANO, Yasuhiro
- UNGVARI, Attila





IJF Grand Prix Tunis 2010

(TUN Tunis, 07-09 May 2010)

-81 kg

38 Judoka

Pool A

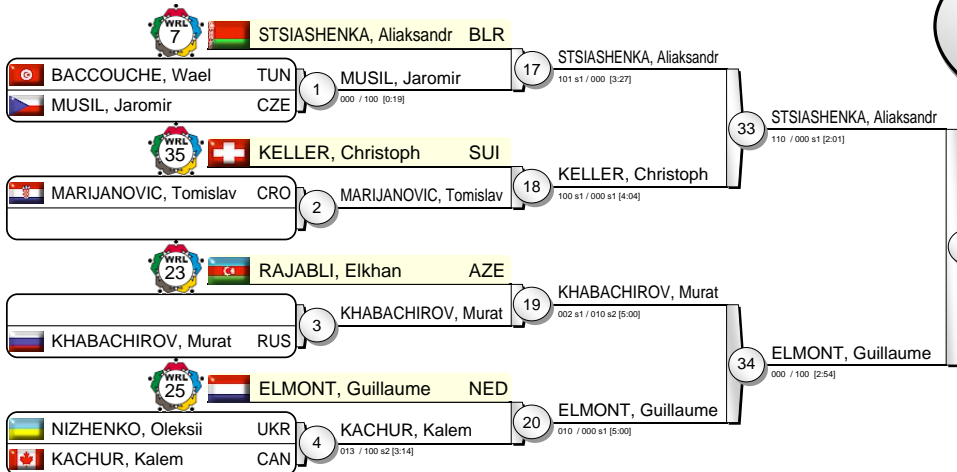

Pool B

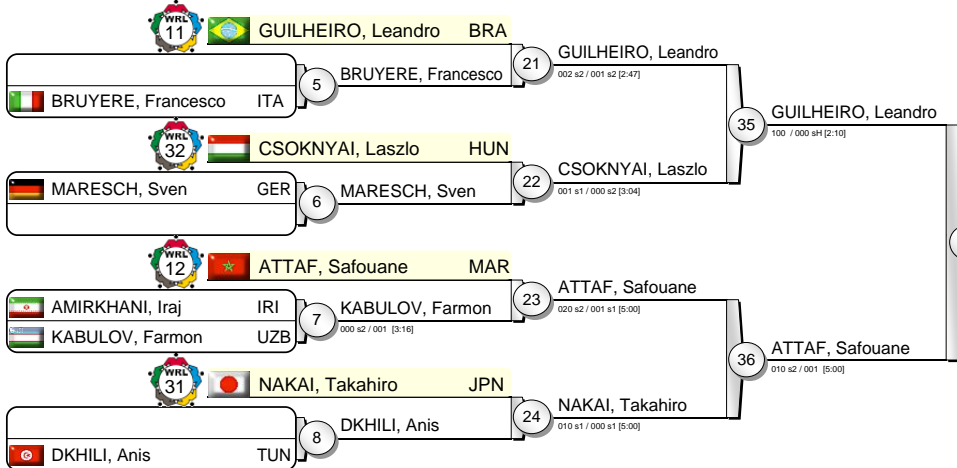

Pool C

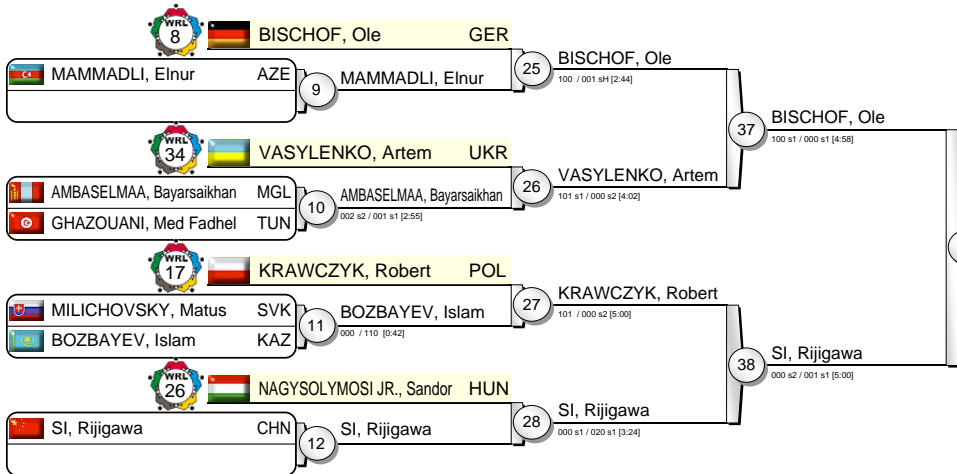

Pool D

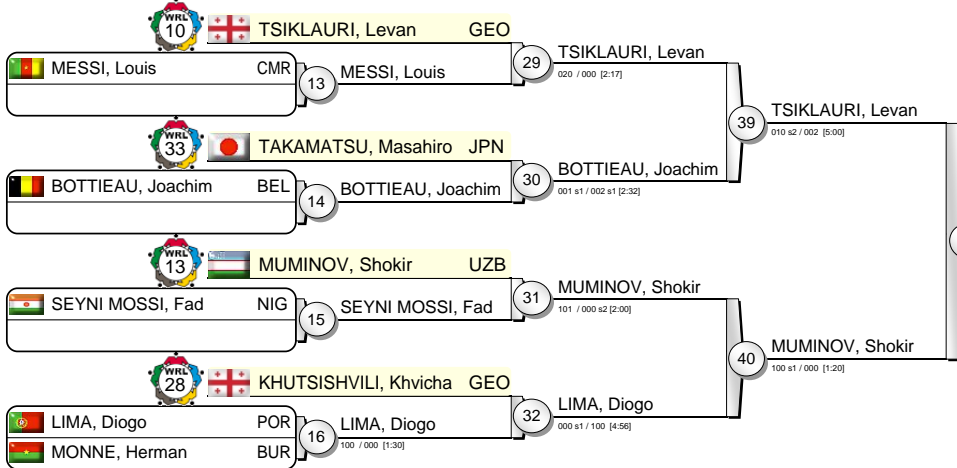

BISCHOF, Ole
000 s2 / 001 s1 [5:00]

BISCHOF, Ole
101 s1 / 000 s2 [3:45]

BISCHOF, Ole
111 s1 / 000 s2 [3:37]

Results

1. BISCHOF, Ole GER
2. GUILHEIRO, Leandro BRA
3. ELMONT, Guillaume NED
3. MUMINOV, Shokir UZB
5. STSIASHENKA, Aliaksandr BLR
5. ATTAF, Safouane MAR
5. SI, Rijigawa CHN
7. TSIKLAURI, Levan GEO





IJF Grand Prix Tunis 2010

(TUN Tunis, 07-09 May 2010)

-90 kg

31 Judoka

Pool A

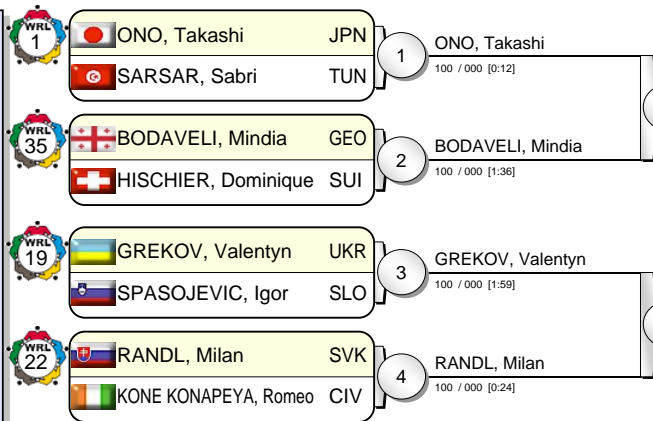

Pool B

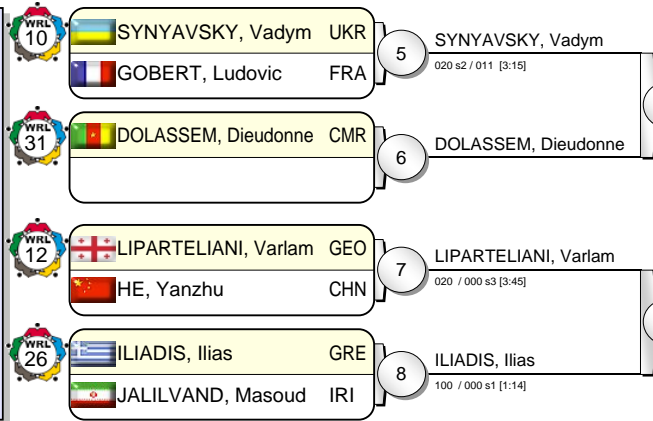

Pool C

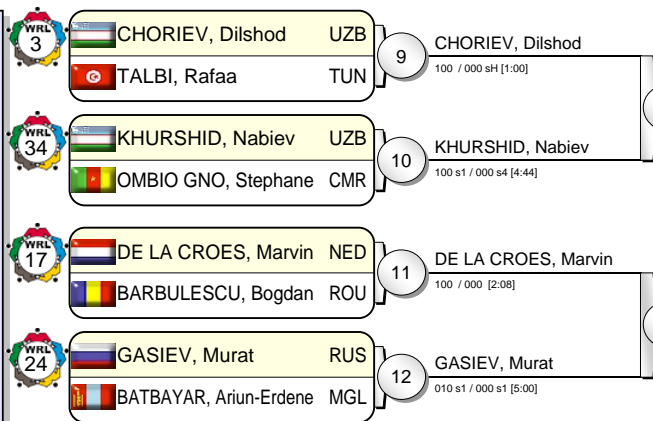

Pool D

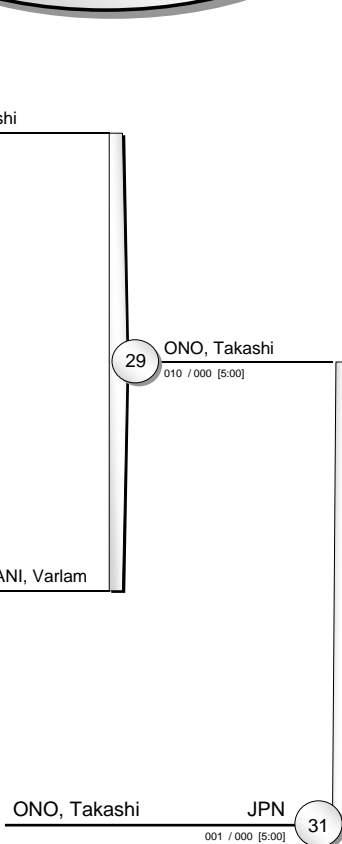
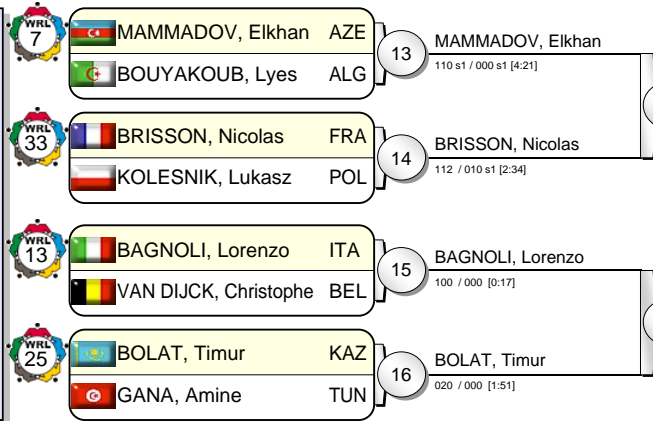

Results

1. ONO, Takashi JPN
2. MAMMADOV, Elkhan AZE
3. LIPARTELIANI, Varlam GEO
3. GASIEV, Murat RUS
5. RANDL, Milan SVK
5. SYNYAVSKY, Vadym UKR
5. KHURSHID, Nabiev UZB
5. BAGNOLI, Lorenzo ITA





IJF Grand Prix Tunis 2010

(TUN Tunis, 07-09 May 2010)

-100 kg

26 Judoka

Pool A

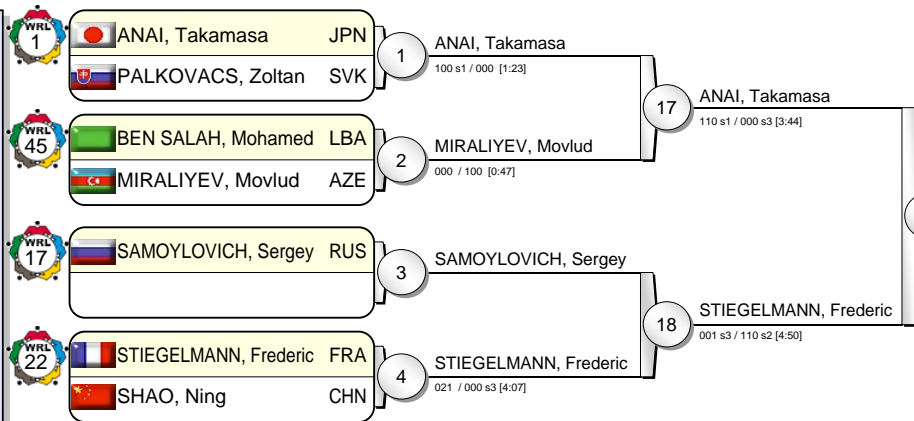

Pool B

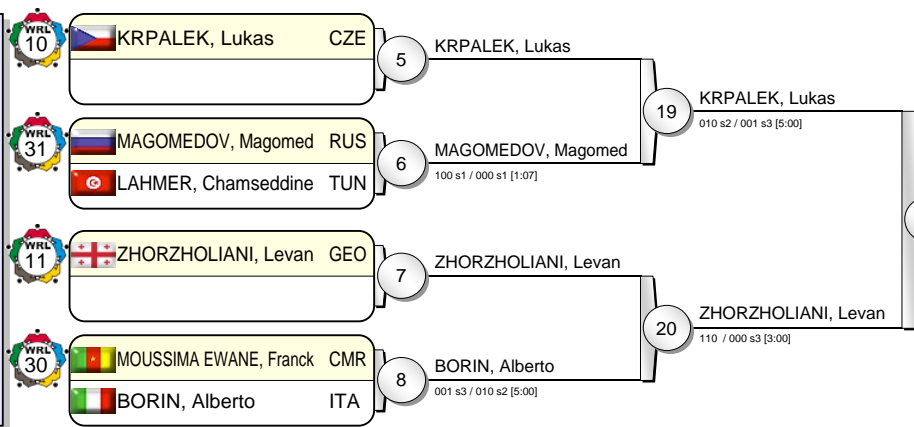

Pool C

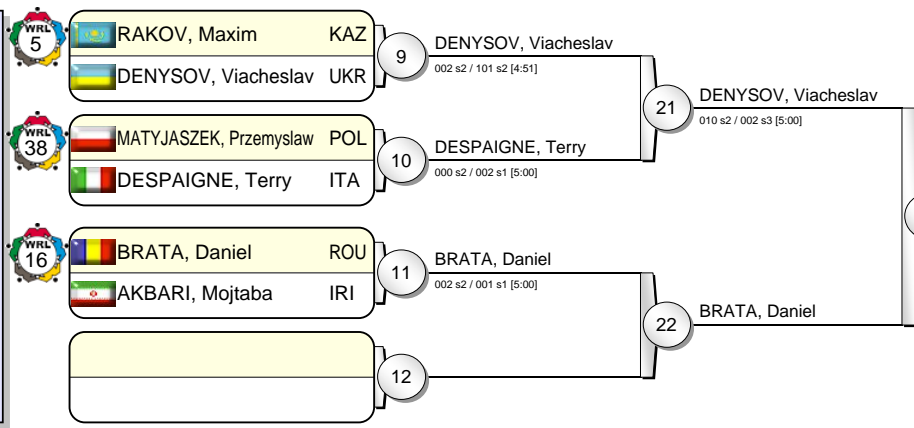

Pool D

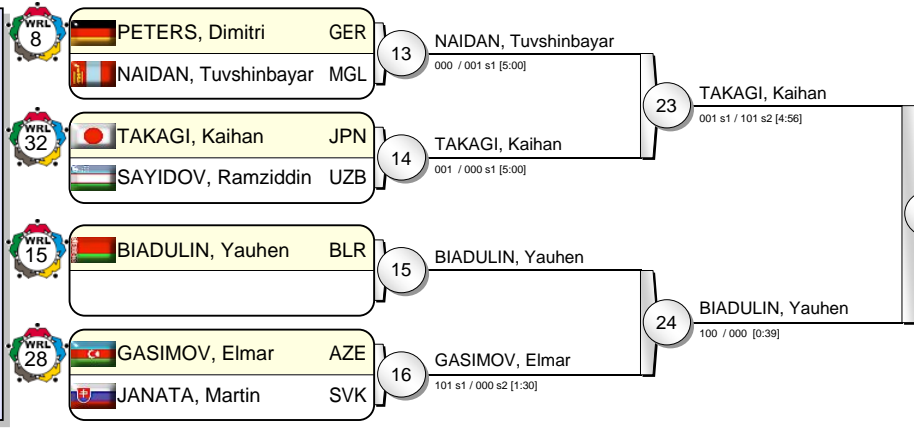

BIADULIN, Yauhen BLR 31
000 / 020 [0:43]

Results

- | | | |
|--------------------------|-----|--|
| 1. BIADULIN, Yauhen | BLR | |
| 2. STIEGELMANN, Frederic | FRA | |
| 3. ZHORZHOLIANI, Levan | GEO | |
| 3. DENYSOV, Viacheslav | UKR | |
| 5. ANAI, Takamasa | JPN | |
| 5. KRPALEK, Lukas | CZE | |
| 5. BRATA, Daniel | ROU | |
| 5. TAKAGI, Kaihan | JPN | |





IJF Grand Prix Tunis 2010

(TUN Tunis, 07-09 May 2010)

+100 kg

21 Judoka

Pool A

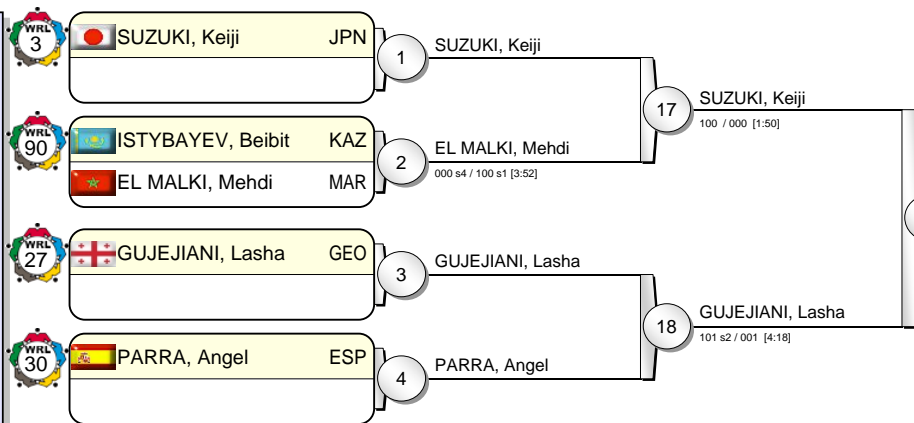

Pool B

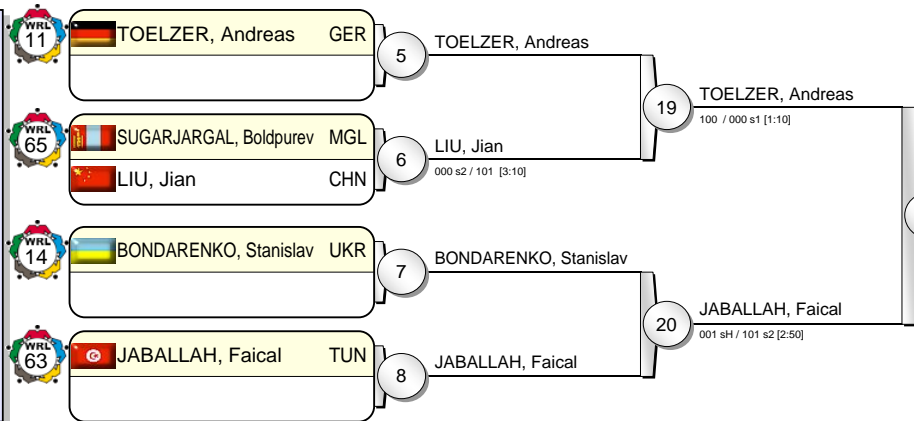

Pool C

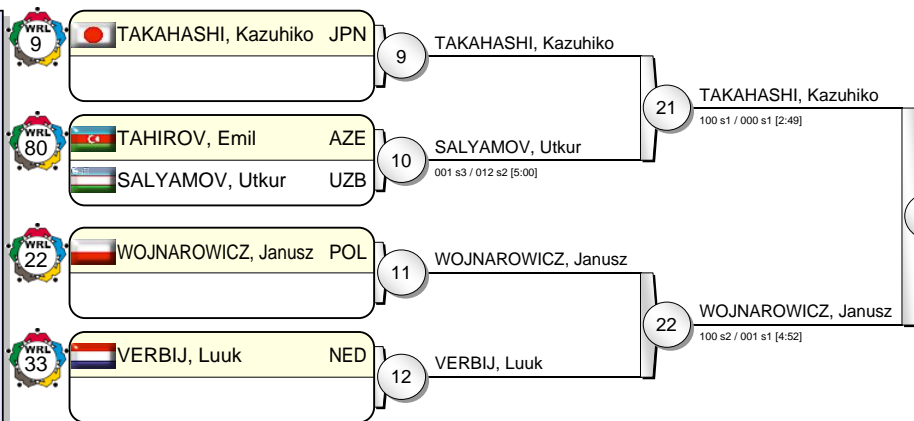

Pool D

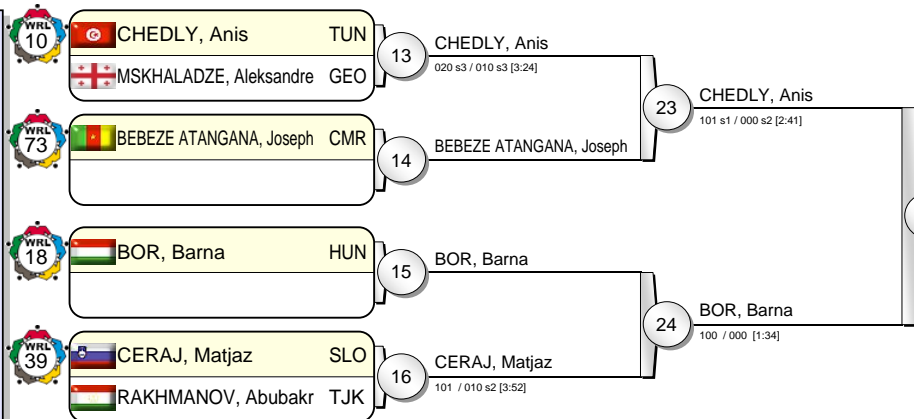

SUZUKI, Keiji JPN 31
020 / 001 [4:06]

Results

- | | | |
|------------------------|-----|--|
| 1. SUZUKI, Keiji | JPN | |
| 2. BOR, Barna | HUN | |
| 3. TOELZER, Andreas | GER | |
| 3. TAKAHASHI, Kazuhiko | JPN | |
| 5. GUJEJIANI, Lasha | GEO | |
| 5. JABALLAH, Faical | TUN | |
| 5. WOJNAROWICZ, Janusz | POL | |
| 5. CHEDLY, Anis | TUN | |





IJF Grand Prix Tunis 2010

(TUN Tunis, 07-09 May 2010)

-48 kg

18 Judoka

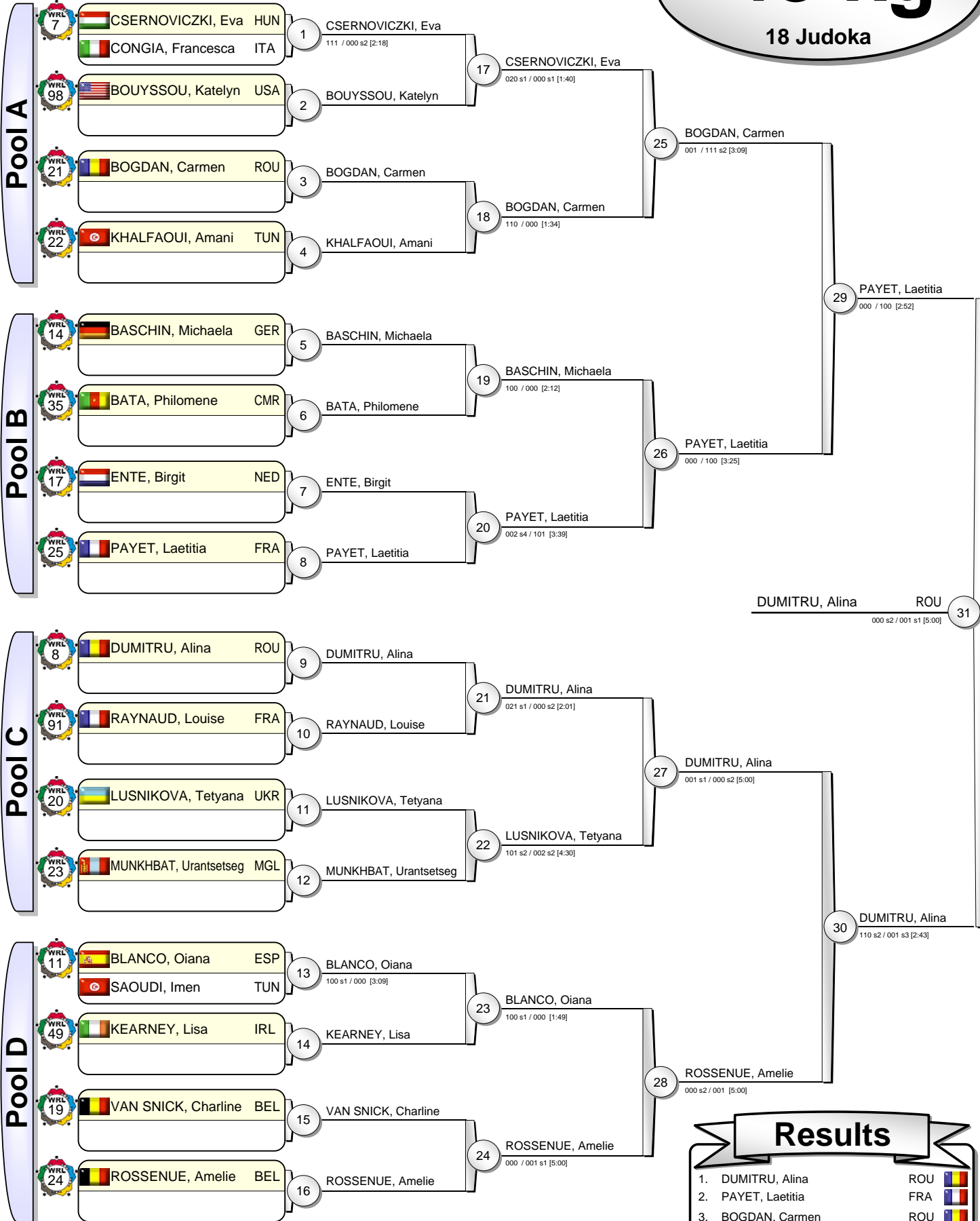

Results

- DUMITRU, Alina (ROU) 🇷🇴
- PAYET, Laetitia (FRA) 🇫🇷
- BOGDAN, Carmen (ROU) 🇷🇴
- ROSSENU, Amelie (BEL) 🇧🇪
- CSERNOVICZKI, Eva (HUN) 🇭🇺
- BASCHIN, Michaela (GER) 🇩🇪
- LUSNIKOVA, Tetyana (UKR) 🇺🇰
- BLANCO, Oiana (ESP) 🇪🇸





IJF Grand Prix Tunis 2010

(TUN Tunis, 07-09 May 2010)

-52 kg

20 Judoka

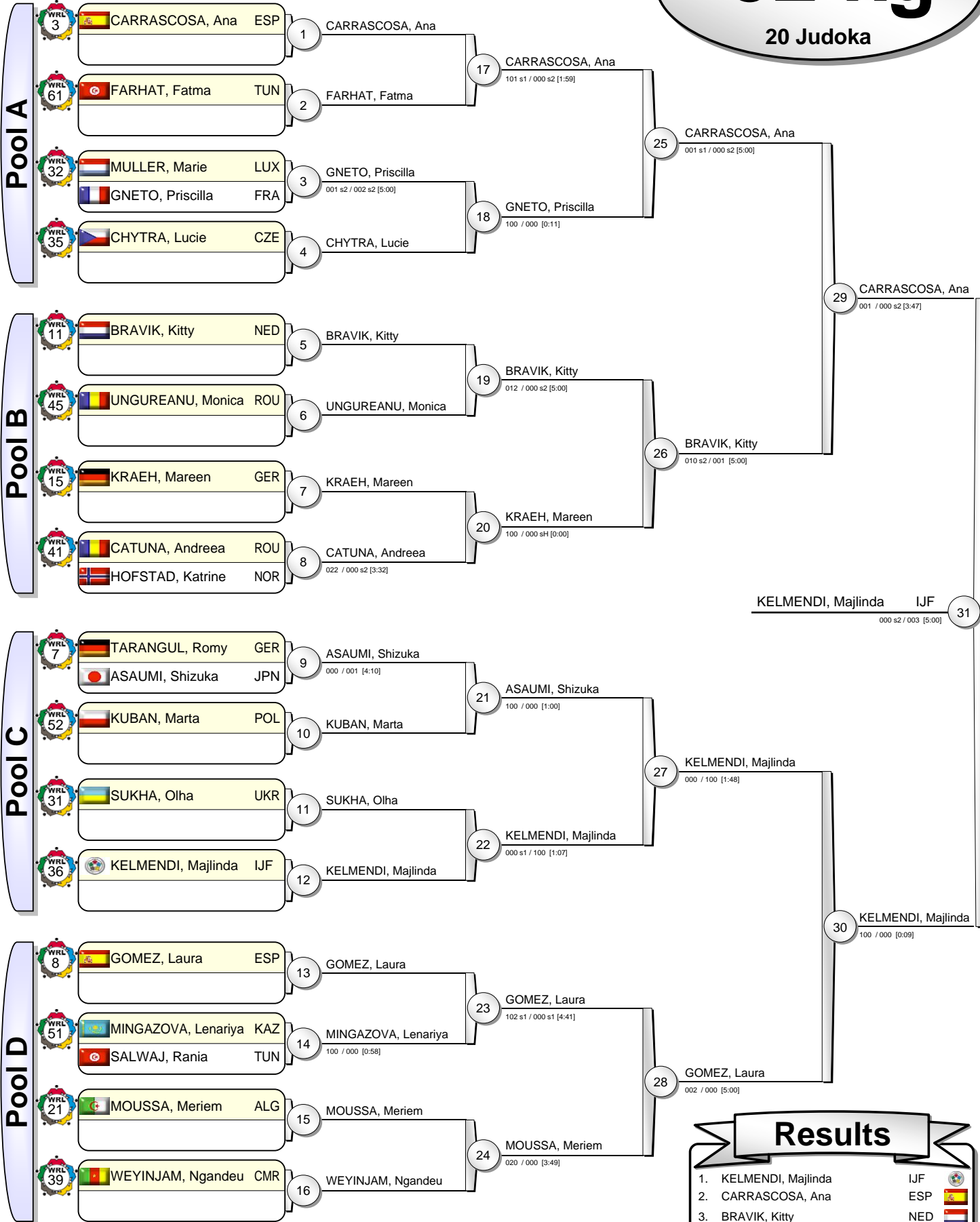

KELMENDI, Majlinda IJF 31
000 s2 / 003 [5:00]

Results

- | | | |
|-----------------------|-----|--|
| 1. KELMENDI, Majlinda | IJF | |
| 2. CARRASCOSA, Ana | ESP | |
| 3. BRAVIK, Kitty | NED | |
| 3. GOMEZ, Laura | ESP | |
| 5. GNETO, Priscilla | FRA | |
| 5. KRAEH, Mareen | GER | |
| 5. ASAUMI, Shizuka | JPN | |
| 5. MOUSSA, Meriem | ALG | |





IJF Grand Prix Tunis 2010

(TUN Tunis, 07-09 May 2010)

-57 kg

18 Judoka

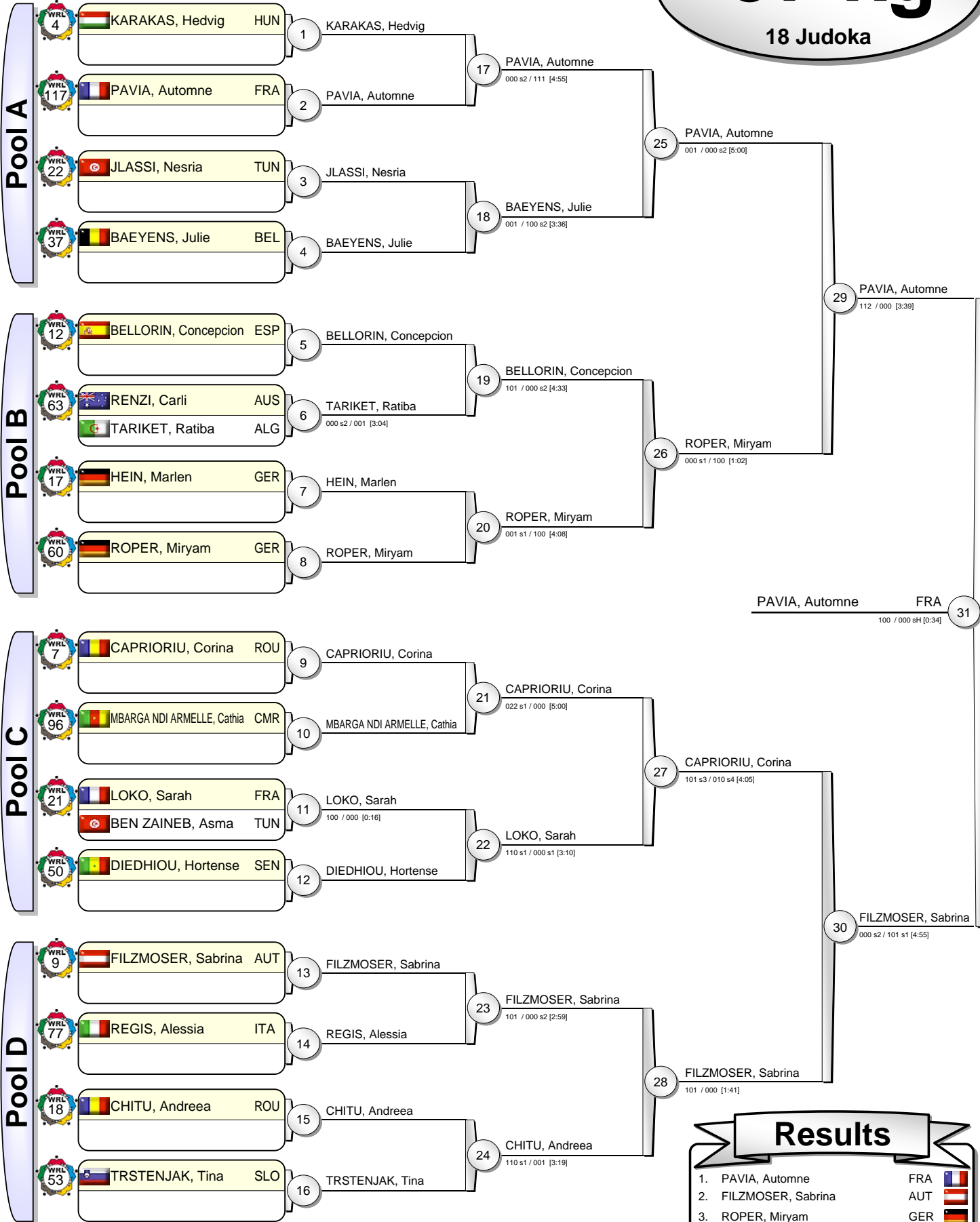

PAVIA, Automne FRA 31
100 / 000 sH [0:34]

Results

- | | | |
|-------------------------|-----|--|
| 1. PAVIA, Automne | FRA | |
| 2. FILZMOSER, Sabrina | AUT | |
| 3. ROPER, Miryam | GER | |
| 3. CAPRIORIU, Corina | ROU | |
| 5. BAEYENS, Julie | BEL | |
| 5. BELLORIN, Concepcion | ESP | |
| 5. LOKO, Sarah | FRA | |
| 5. CHITU, Andreea | ROU | |





IJF Grand Prix Tunis 2010

(TUN Tunis, 07-09 May 2010)

-63 kg

20 Judoka

Pool A

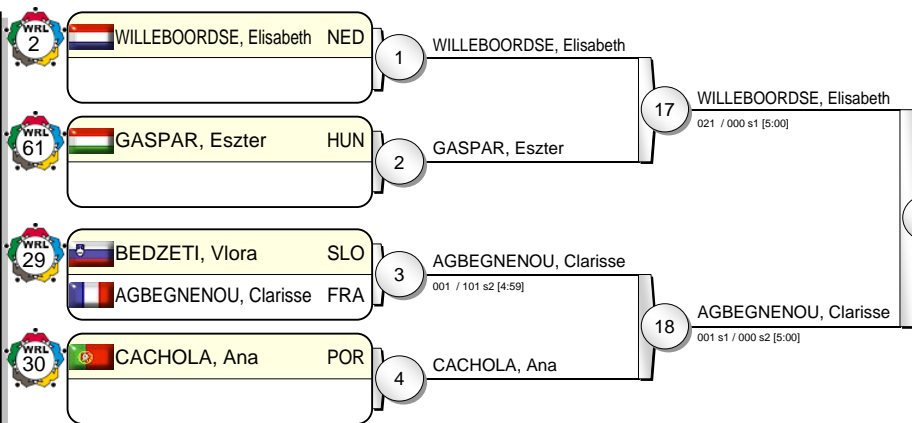

Pool B

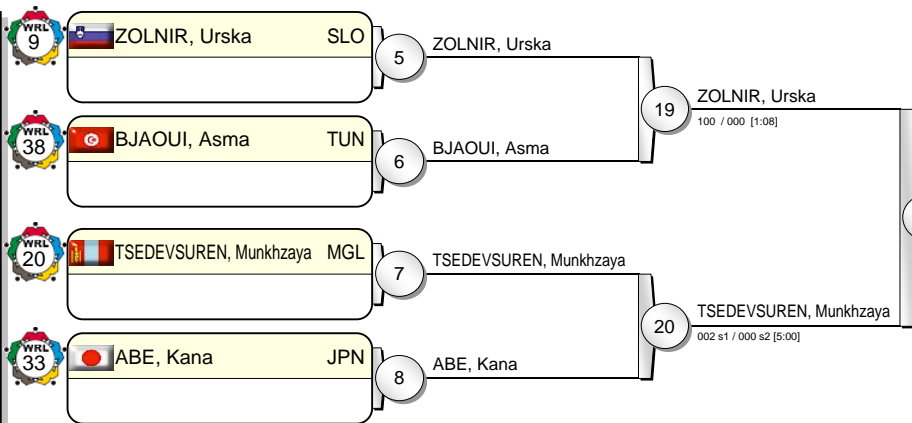

Pool C

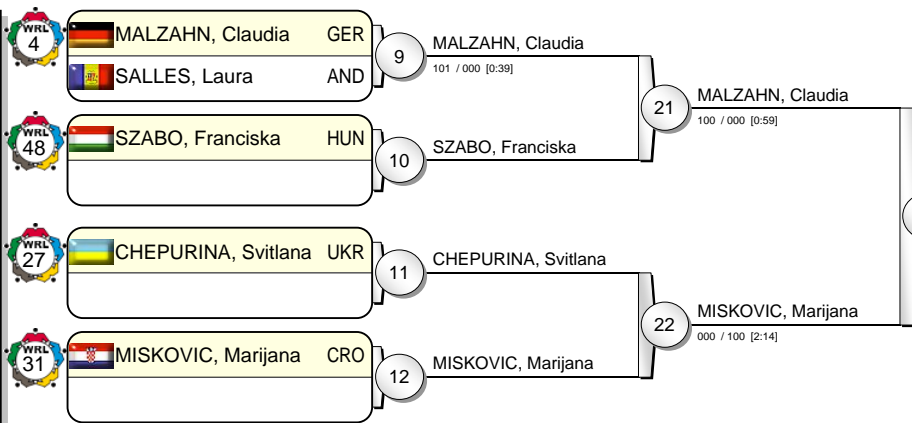

Pool D

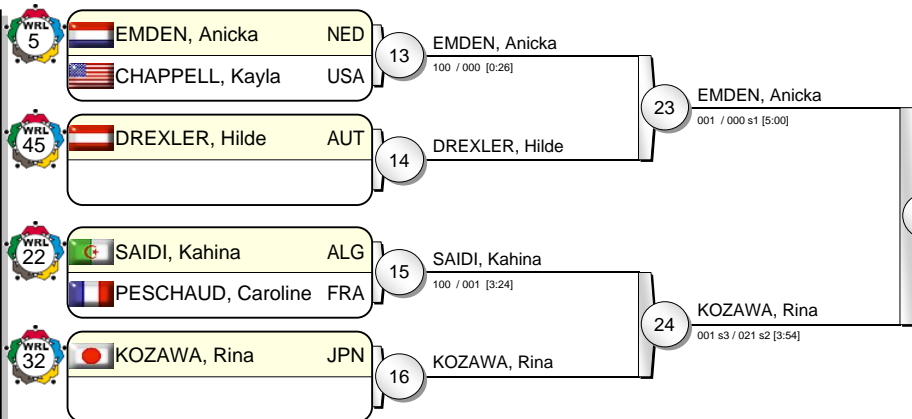

MALZAHN, Claudia GER 31
000 s1 / 110 [2:07]

Results

- MALZAHN, Claudia GER
- WILLEBOORDSE, Elisabeth NED
- ZOLNIR, Urska SLO
- EMDEN, Anicka NED
- AGBEGNEU, Clarisse FRA
- TSEDEVSUREN, Munkhzaya MGL
- MISKOVIC, Marijana CRO
- KOZAWA, Rina JPN





IJF Grand Prix Tunis 2010

(TUN Tunis, 07-09 May 2010)

-70 kg

17 Judoka

Pool A

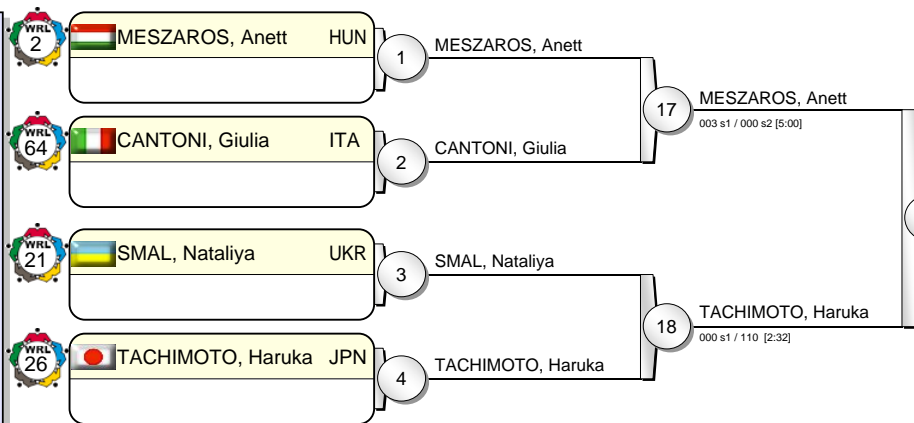

Pool B

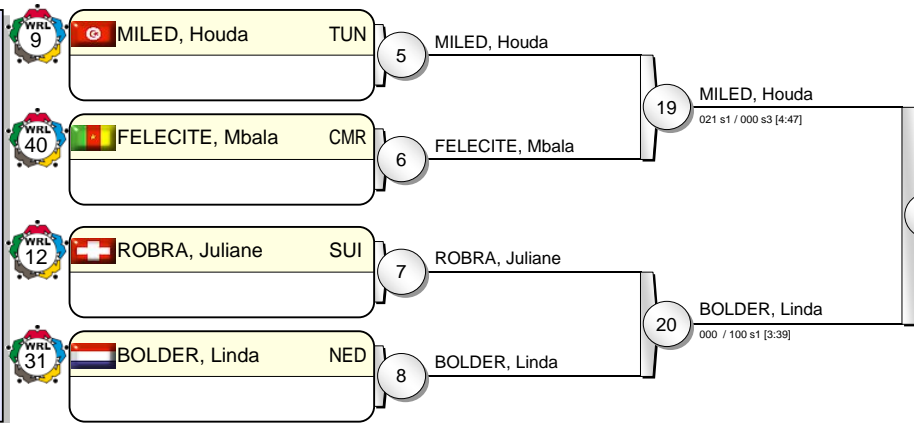

Pool C

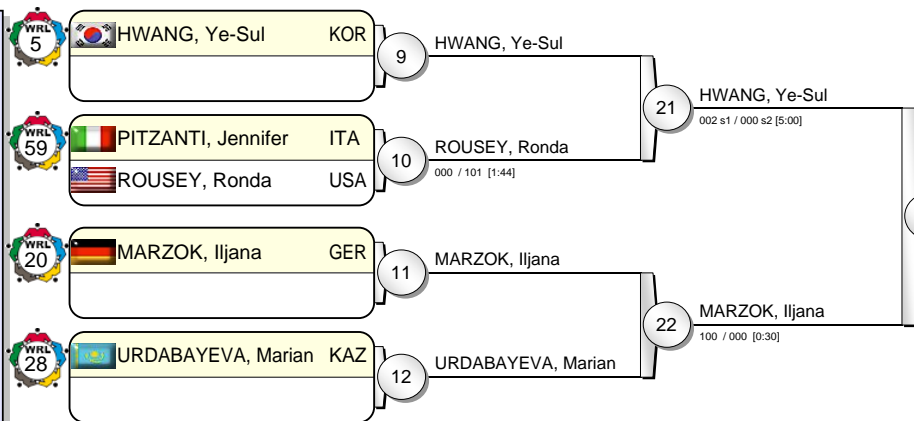

Pool D

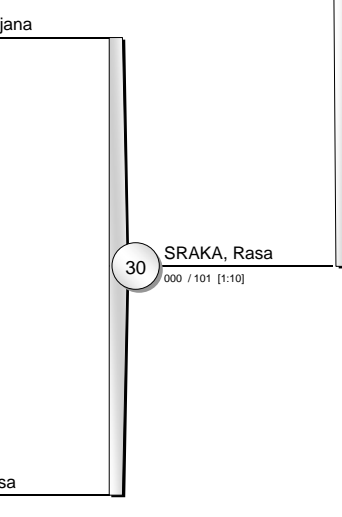
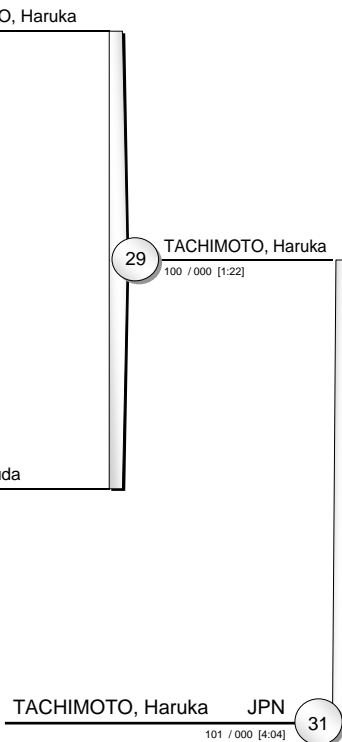
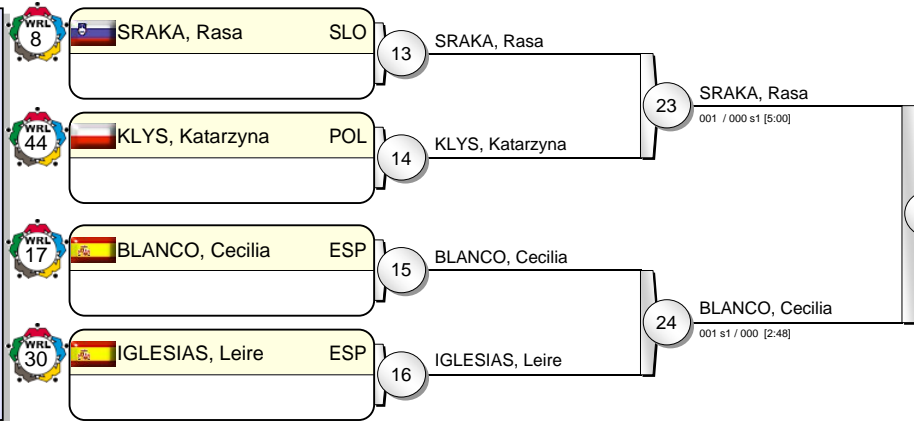

Results

- | | | |
|----------------------|-----|--|
| 1. TACHIMOTO, Haruka | JPN | |
| 2. SRAKA, Rasa | SLO | |
| 3. MILED, Houda | TUN | |
| 3. MARZOK, Iljana | GER | |
| 5. MESZAROS, Anett | HUN | |
| 5. BOLDER, Linda | NED | |
| 5. HWANG, Ye-Sul | KOR | |
| 5. BLANCO, Cecilia | ESP | |





IJF Grand Prix Tunis 2010

(TUN Tunis, 07-09 May 2010)

-78 kg

18 Judoka

Pool A

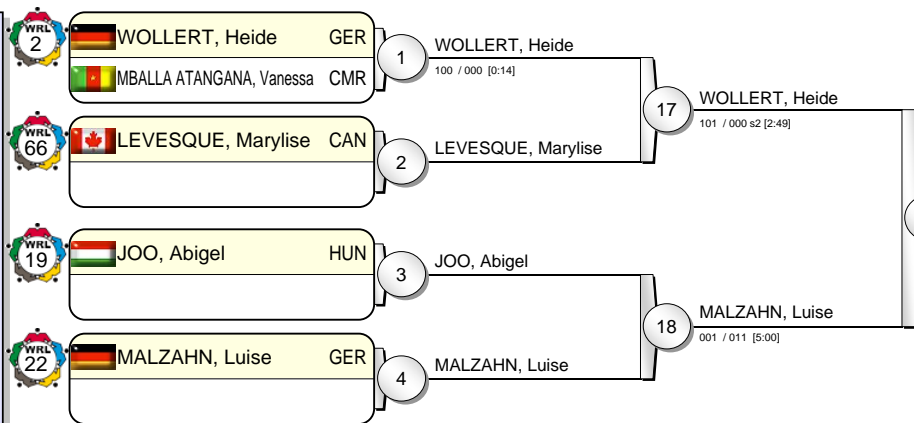

Pool B

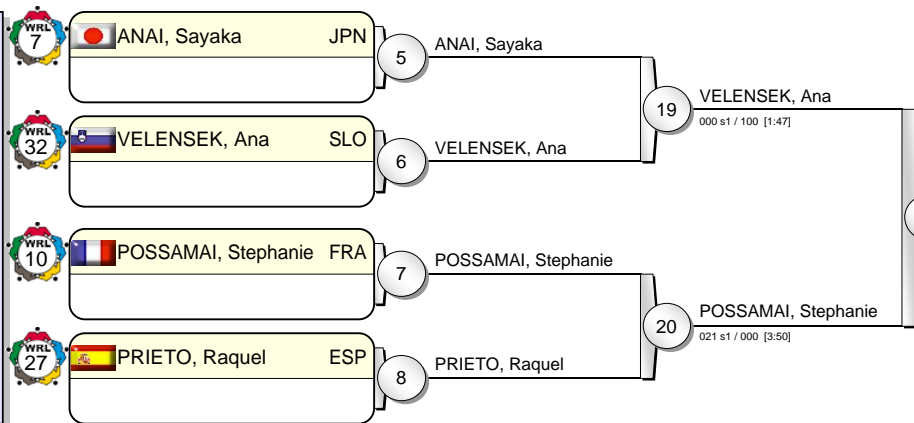

Pool C

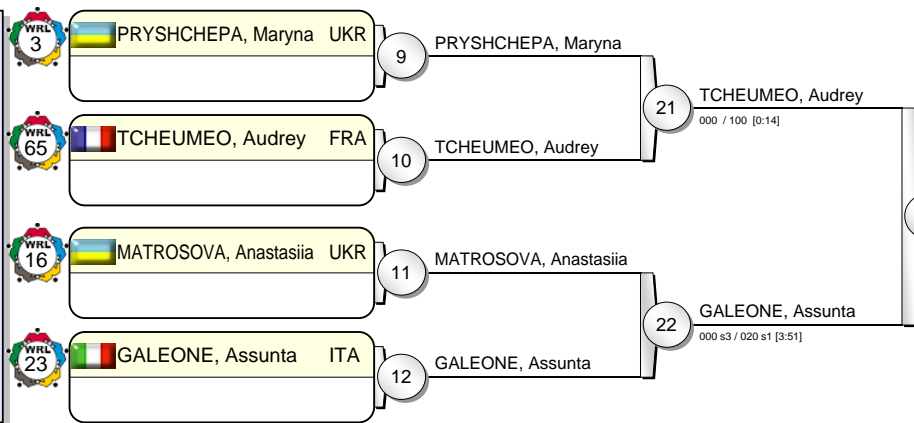

Pool D

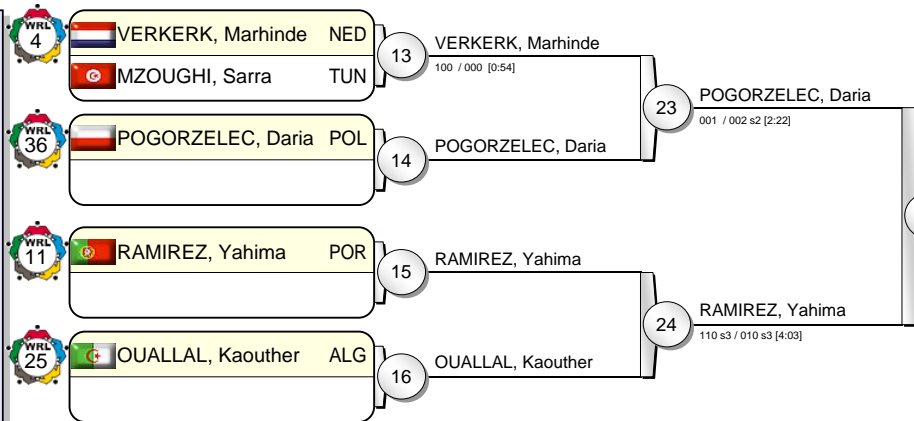

TCHEUMEO, Audrey FRA 31
000 / 110 [0:57]

Results

- | | | | |
|----|---------------------|-----|--|
| 1. | TCHEUMEO, Audrey | FRA | |
| 2. | WOLLERT, Heide | GER | |
| 3. | POSSAMAI, Stephanie | FRA | |
| 3. | POGORZELEC, Daria | POL | |
| 5. | MALZAHN, Luise | GER | |
| 5. | VELENSEK, Ana | SLO | |
| 5. | GALEONE, Assunta | ITA | |
| 5. | RAMIREZ, Yahima | POR | |





IJF Grand Prix Tunis 2010

(TUN Tunis, 07-09 May 2010)

+78 kg

14 Judoka

Pool A

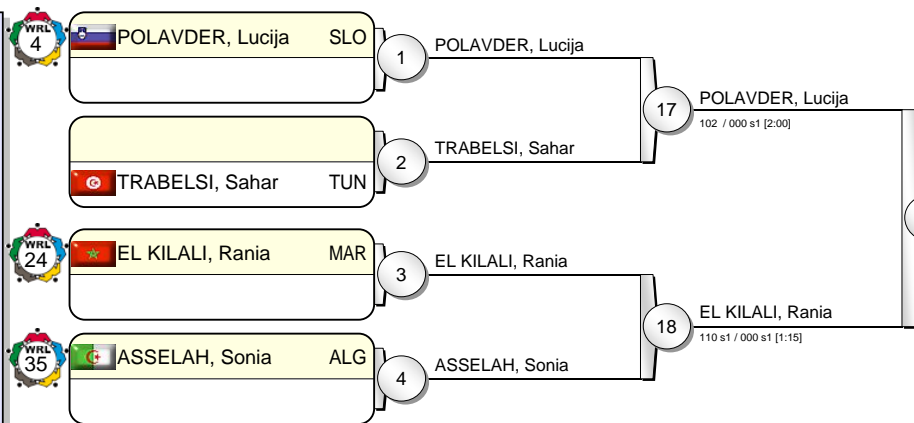

Pool B

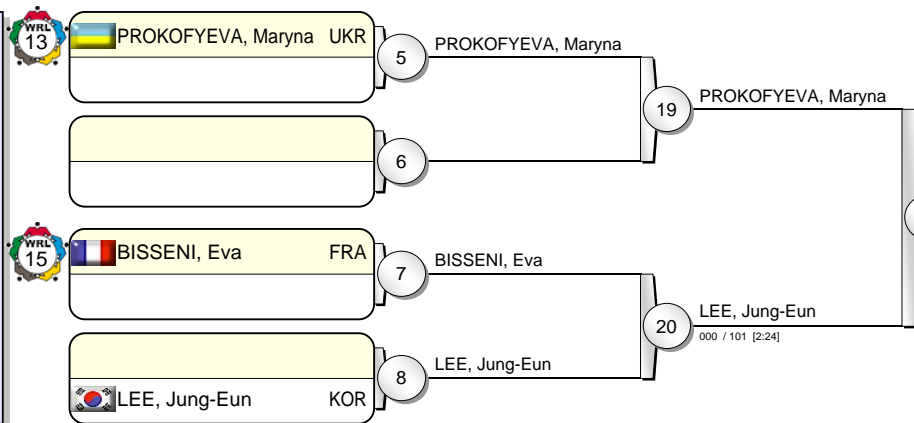

Pool C

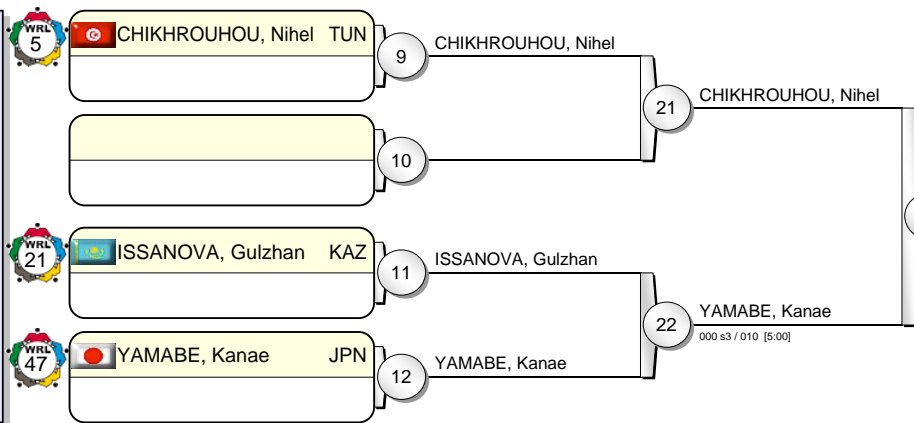

Pool D

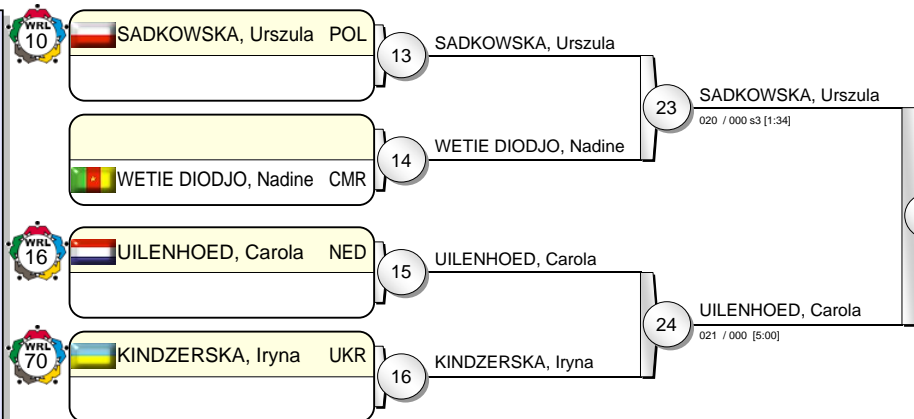

POLAVDER, Lucija SLO 31
012 / 000 [5:00]

Results

- | | | |
|-----------------------|-----|--|
| 1. POLAVDER, Lucija | SLO | |
| 2. CHIKHROUHOU, Nihel | TUN | |
| 3. LEE, Jung-Eun | KOR | |
| 3. SADKOWSKA, Urszula | POL | |
| 5. EL KILALI, Rania | MAR | |
| 5. PROKOFYEVA, Maryna | UKR | |
| 5. YAMABE, Kanae | JPN | |
| 5. UILENHOED, Carola | NED | |

